

COMPONENTS

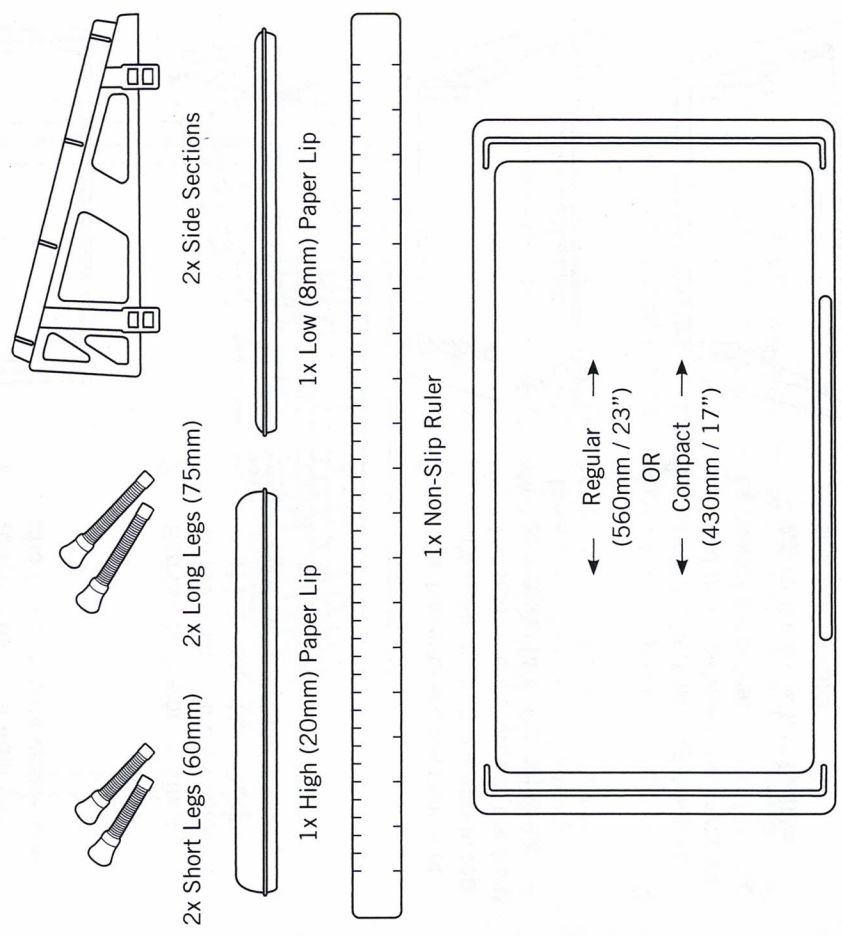

1x Platform Top

Depending on your purchase, your box will include either the **Regular** platform size (560mm / 23" wide) or the **Compact** platform size (430mm / 17" wide).

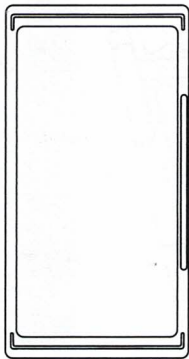

1 Remove platform from the box and place on desk upside down.

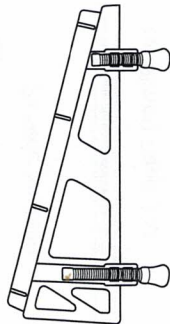

2 Remove both side sections and all four legs from bag. Screw two short legs into shorter section of side at the front and two long legs into section of side at rear.

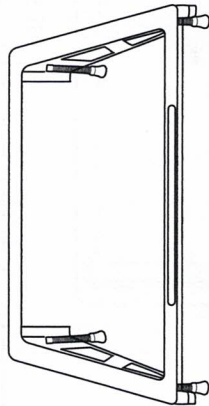

3 Take two side sections and slot into position on the platform top. The narrow edge goes at the front and adjacent to the paper slot.

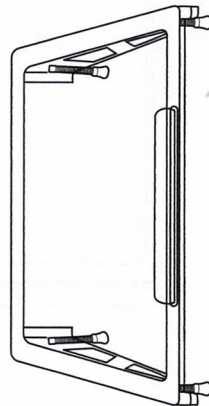

4 Turn platform the right way up and place between the keyboard and the monitor.
Adjust the screw feet for height and slope comfort.

Place paper lip in slot at front of the Microdesk™. There is a choice of two heights of paper lip for your personal convenience.

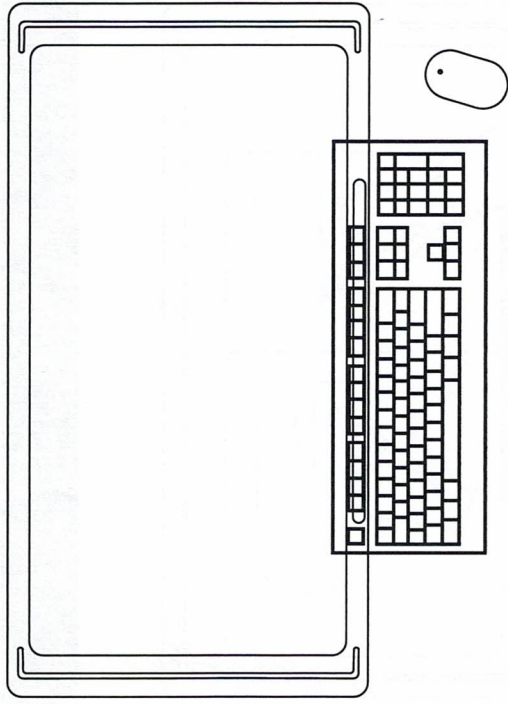

1 Position the front edge of the Microdesk™ so that it overlaps the top key row of the keyboard. Place the mouse to the side of the keyboard in front of the Microdesk™.

2 Adjust the height of the Microdesk™ so your fingers fit easily under the Microdesk™ to reach the function keys.

3 If the keyboard is not in use, you can move the Microdesk™ towards you for reading and writing in a relaxed position.



HOW TO USE

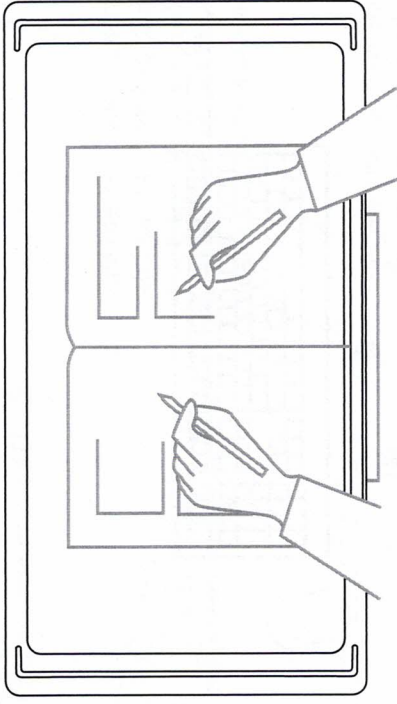

- 1** | The Microdesk™ suits both left and right hand writers.
When using the high profile paper lip, position papers for writing to the side of the central lip so your wrist is on the flat section for writing. If only a few papers are on the Microdesk™ platform, use the low profile paper lip for ease of writing.
- 2** | The Compact platform 430mm / 17" size is recommended for smaller work spaces; also when you have a laptop elevated on a stand with a separate keyboard. Position the Compact Microdesk™ between the raised laptop and your keyboard.
- 3** | Straight Sides are available as an extra if you are needing a lower rear height or you have a keyboard tray – see website for details.
- 4** | Do not LEAN on the Microdesk™ .
- 5** | The non slip ruler is available to help you keep track of your paperwork.

